

LP377PBG1-60G

Features

- Water Clear Lens
- Low Profile
- 4 Pin Plastic Package
- High Flux Output
- High Current Operation

Applications

- Automotive Interior Exterior Lighting
- Rail Signals
- Traffic Control Devices
- Channel Letters
- Strip Lighting
- Architectural Lighting

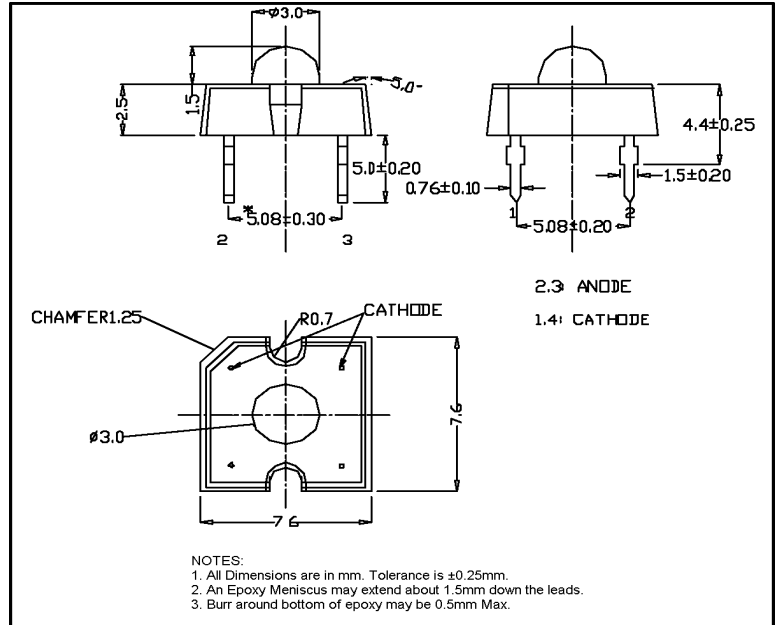

Maximum Ratings (Ta=25°C)

Characteristic	Symbol	Max.	Unit
Forward Current	I _F	30	mA
Reverse Voltage	V _R	5	V
Power Dissipation	P _D	120.00	mW
Operating Temperature	T _{opr}	-20 ~ +75	°C
Storage Temperature	T _{stg}	-30 ~ +80	°C
Soldering Temperature	T _{sol}	260	°C
Soldering Time	-	for 3 sec. max	-



ATTENTION
OBSERVE PRECAUTIONS
ELECTROSTATIC
SENSITIVE DEVICES

Opto-Electrical Characteristics (Ta=25°C)

Characteristic	Symbol	Test Condition	Min	Typ	Max	Unit
Forward Voltage	V _F	I _F =30mA	3.60	4.00	4.60	V
Reverse Current	I _R	V _R =5V	-	-	100	μA
Luminous Flux	Φ	I _F =30mA	1000.00	2000.00	-	mlm
Viewing Angle	2θ ^{1/2}	-	-	60°	-	deg.
Peak Wavelength	λ _p	I _F =30mA	-	502	-	nm
Dominant Wavelength	λ _d	I _F =30mA	-	505	-	nm
Spectral Line Half Width	Δλ	I _F =30mA	-	38	-	nm

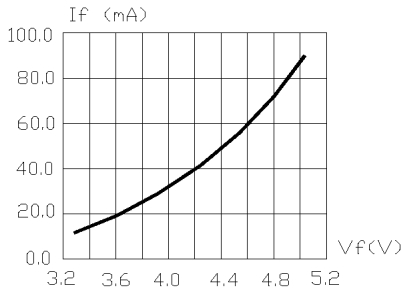

FIG.1 FORWARD CURRENT VS. FORWARD VOLTAGE.

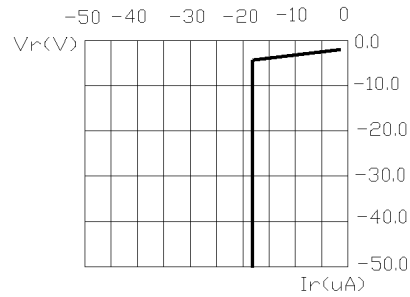

FIG.2 REVERSE CURRENT VS. REVERSE VOLTAGE.

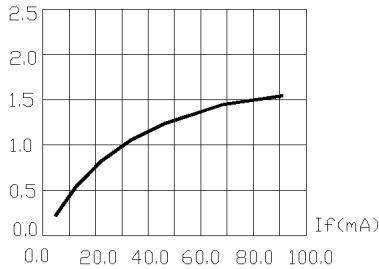

FIG.3 RELATIVE LUMINOUS FLUX VS. FORWARD CURRENT.

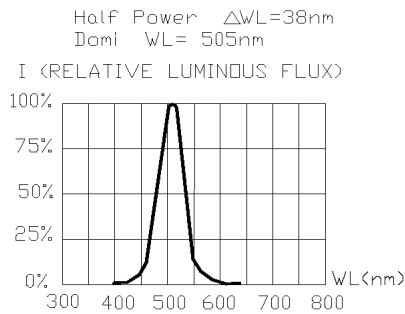

FIG.4 RELATIVE LUMINOUS FLUX VS. WAVELENGTH.

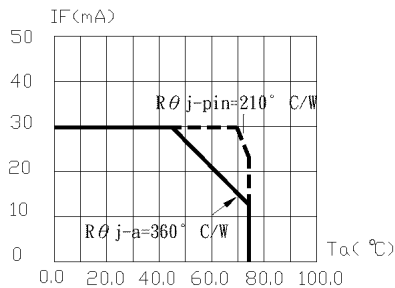

FIG.5 MAXIMUM FORWARD DC CURRENT VS AMBIENT TEMPERATURE ($T_{jmax}=95^{\circ}C$)

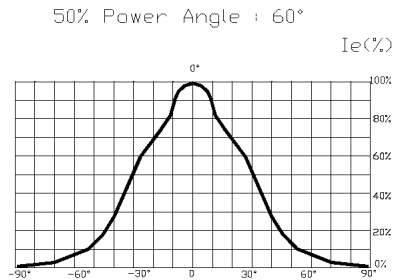

FIG.6 FAR FIELD PATTERN

1. Cathode PAD Area (0.18 × 0.18 × 2inch²)
2. Height above nominal seating plane in inches(0.3inch)